

Adjustable Hangers

Adjustable Suspension Hanging System

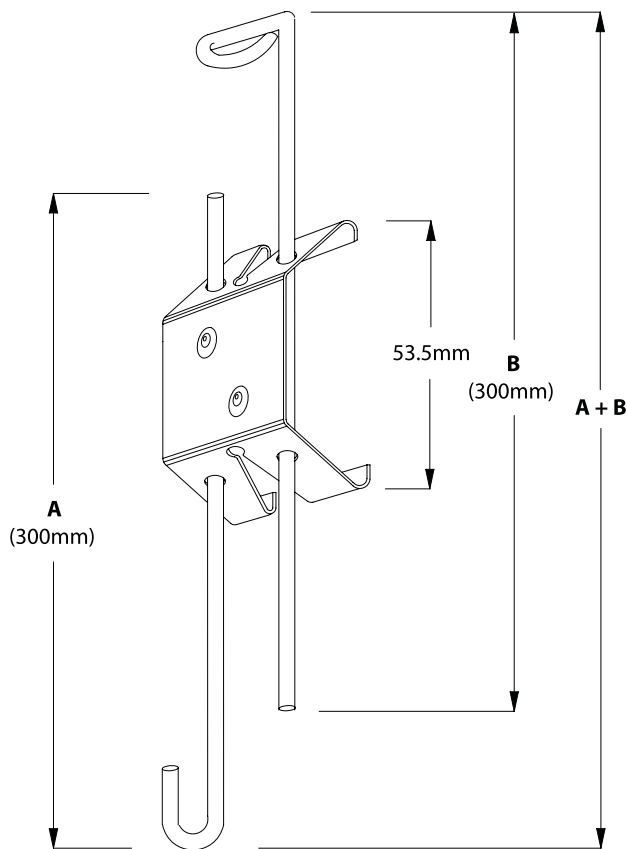

Length of Bottom Hanger (mm) A	Length of Top Hanger (mm) B	Minimum Overall Length (mm) B	Maximum Overall Length (mm) A + B
250	250	250	450
300	300	300	550
300	500	500	750
300	600	600	850
300	750	750	1000
300	1000	1000	1250
300	1200	1200	1450
300	1500	1500	1750
300	2000	2000	2250
300	3000	3000	3250

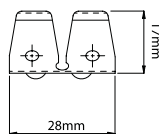
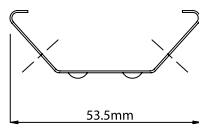

HDC/3 (3mm) - HDC/4 (4mm) Double Spring Clip

Double Spring Clip for Use in Adjustable Hanging Systems

Material Spring Steel Zinc Plated or Black Phosphate

Packed 500 per box

Weight per 100 0.92kg

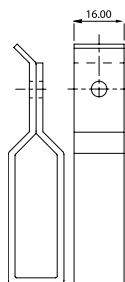

HSB12 - HSB15 - HSB19 Channel Bracket

Galvanised Mild Steel

Part No.	Channel Size	Wt. Per 100	Packed
HSB12	12 x 38mm	1.83 kg	500 per box
HSB15	15 x 45mm	1.92 kg	500 per box
HSB19	19 x 38mm	1.95 kg	500 per box



Arthur Hough & Sons Ltd.

Hilton Cross Business Park, Cannock Road, Featherstone, Wolverhampton, WV10 7QZ

Tel: +44 (0) 1902 867718 Fax: +44 (0) 1902 867719

Email: sales@ahough.com Website: www.ahough.com

Adjustable Hangers

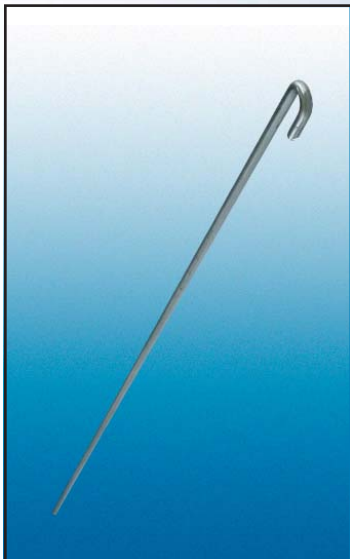
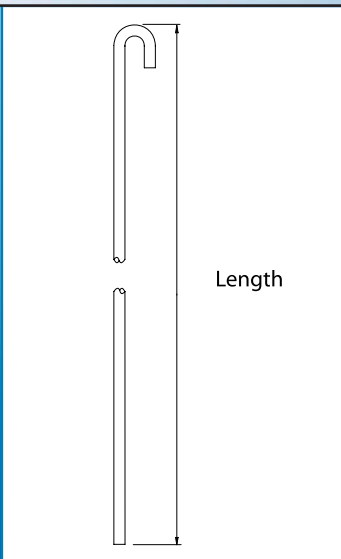
HTH - Top Hanger with Hook Fixing

Part No.	Length (mm)	Weight Per 100 (kg)	
		3mm	4mm
HTH30	300	1.99	3.53
HTH50	500	3.36	5.99
HTH60	600	3.93	7.00
HTH75	750	4.73	8.59
HTH100	1000	6.20	11.13
HTH120	1200	7.56	13.23
HTH150	1500	9.14	15.44

Material Galvanised Mild Steel Wire
Packed 50 per bundle

HTR - Top Hanger with 90° Screw Fixing

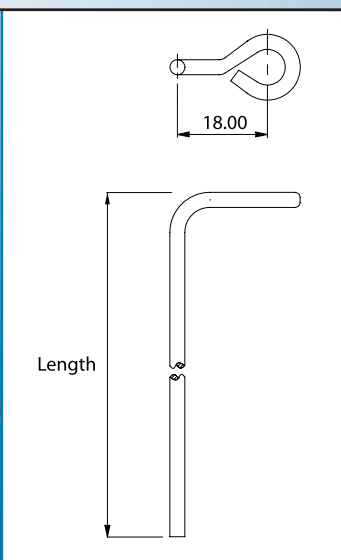
Part No.	Length (mm)	Weight Per 100 (kg)	
		3mm	4mm
HTR30	300	1.99	3.53
HTR50	500	3.36	5.99
HTR60	600	3.93	7.00
HTR75	750	4.73	8.59
HTR100	1000	6.20	11.13
HTR120	1200	7.56	13.23
HTR150	1500	9.14	15.44

Material Galvanised Mild Steel Wire
Packed 50 per bundle

HBH Bottom Hanger with Hook Fixing (300mm Length)

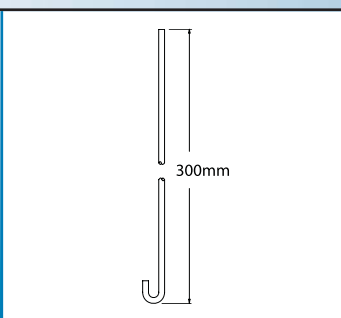
Material Galvanised Mild Steel Wire
Packed 50 per bundle

Available in 3mm & 4mm diameter

HBO Bottom Hanger with Open Hook (300mm Length)

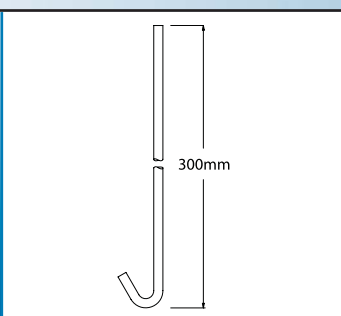
Material Galvanised Mild Steel Wire
Packed 50 per bundle

Available in 3mm & 4mm diameter



Arthur Hough & Sons Ltd.

Hilton Cross Business Park, Cannock Road, Featherstone, Wolverhampton, WV10 7QZ

Tel: +44 (0) 1902 867718 Fax: +44 (0) 1902 867719

Email: sales@ahough.com Website: www.ahough.com