

Adjustable Hangers

Adjustable Suspension Hanging System

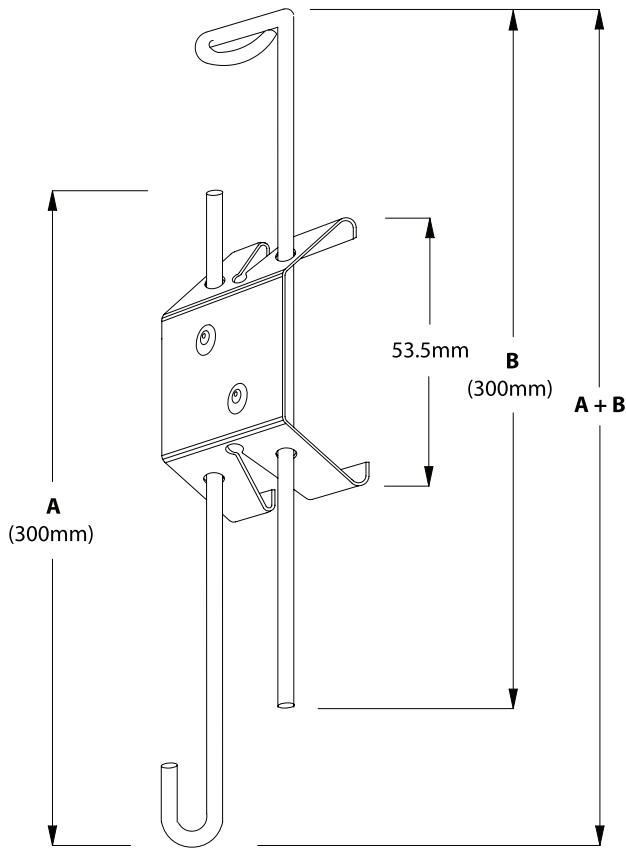

| Length of Bottom Hanger (mm) A | Length of Top Hanger (mm) B | Minimum Overall Length (mm) B | Maximum Overall Length (mm) A + B |
|-----------------------------------|--------------------------------|----------------------------------|--------------------------------------|
| 250 | 250 | 250 | 450 |
| 300 | 300 | 300 | 550 |
| 300 | 500 | 500 | 750 |
| 300 | 600 | 600 | 850 |
| 300 | 750 | 750 | 1000 |
| 300 | 1000 | 1000 | 1250 |
| 300 | 1200 | 1200 | 1450 |
| 300 | 1500 | 1500 | 1750 |
| 300 | 2000 | 2000 | 2250 |
| 300 | 3000 | 3000 | 3250 |

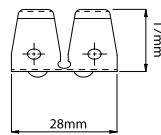
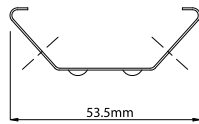
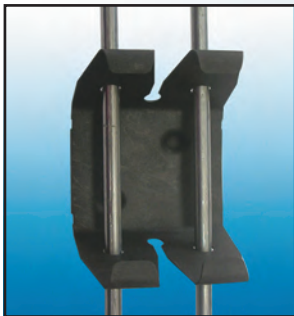

HDC/3 (3mm) - HDC/4 (4mm) Double Spring Clip

Double Spring Clip for Use in Adjustable Hanging Systems

Material Spring Steel Delta Tone or Black Phosphate

Packed 500 per box

Weight per 100 0.92kg

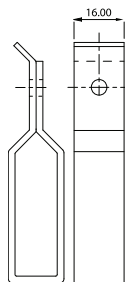

HSB12 - HSB15 - HSB19 Channel Bracket

Galvanised Mild Steel

| Part No. | Channel Size | Wt. Per 100 | Packed |
|----------|--------------|-------------|-------------|
| HSB12 | 12 x 38mm | 1.83 kg | 500 per box |
| HSB15 | 15 x 45mm | 1.92 kg | 500 per box |
| HSB19 | 19 x 38mm | 1.95 kg | 500 per box |



Arthur Hough & Sons Ltd.

Hilton Cross Business Park, Cannock Road, Featherstone, Wolverhampton, WV10 7QZ

Tel: +44 (0) 1902 867718 Fax: +44 (0) 1902 867719

Email: sales@ahough.com Website: www.ahough.com

Adjustable Hangers

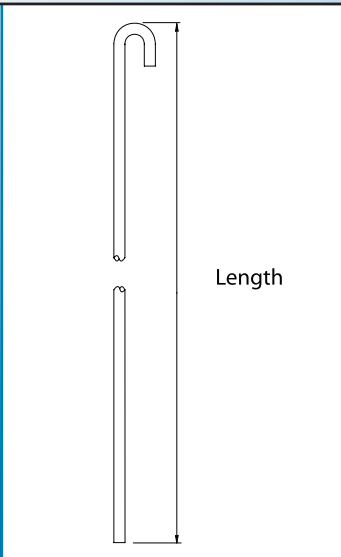
HTH - Top Hanger with Hook Fixing

| Part No. | Length (mm) | Weight Per 100 (kg) | |
|----------|-------------|---------------------|-------|
| | | 3mm | 4mm |
| HTH30 | 300 | 1.99 | 3.53 |
| HTH50 | 500 | 3.36 | 5.99 |
| HTH60 | 600 | 3.93 | 7.00 |
| HTH75 | 750 | 4.73 | 8.59 |
| HTH100 | 1000 | 6.20 | 11.13 |
| HTH120 | 1200 | 7.56 | 13.23 |
| HTH150 | 1500 | 9.14 | 15.44 |

Material Galvanised Mild Steel Wire
Packed 50 per bundle

HTR - Top Hanger with 90° Screw Fixing

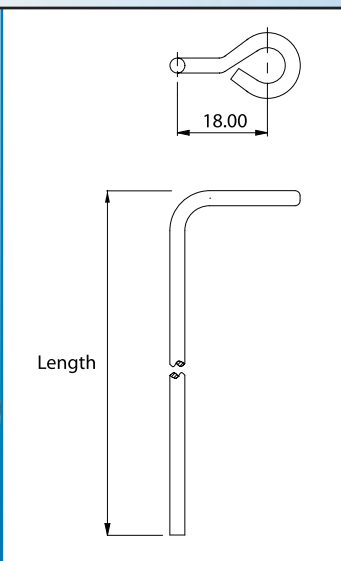
| Part No. | Length (mm) | Weight Per 100 (kg) | |
|----------|-------------|---------------------|-------|
| | | 3mm | 4mm |
| HTR30 | 300 | 1.99 | 3.53 |
| HTR50 | 500 | 3.36 | 5.99 |
| HTR60 | 600 | 3.93 | 7.00 |
| HTR75 | 750 | 4.73 | 8.59 |
| HTR100 | 1000 | 6.20 | 11.13 |
| HTR120 | 1200 | 7.56 | 13.23 |
| HTR150 | 1500 | 9.14 | 15.44 |

Material Galvanised Mild Steel Wire
Packed 50 per bundle

HBH Bottom Hanger with Hook Fixing (300mm Length)

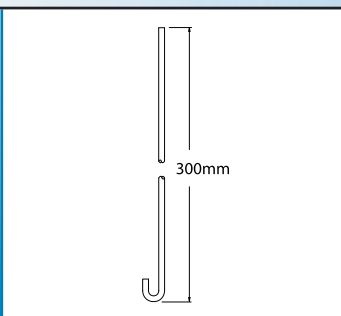
Material Galvanised Mild Steel Wire
Packed 50 per bundle

Available in 3mm & 4mm diameter

HBO Bottom Hanger with Open Hook (300mm Length)

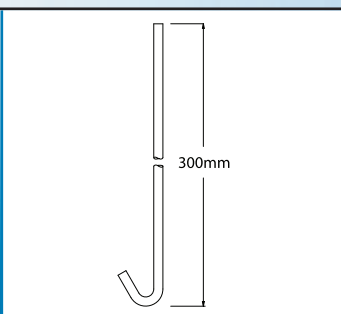
Material Galvanised Mild Steel Wire
Packed 50 per bundle

Available in 3mm & 4mm diameter



Arthur Hough & Sons Ltd.

Hilton Cross Business Park, Cannock Road, Featherstone, Wolverhampton, WV10 7QZ

Tel: +44 (0) 1902 867718 Fax: +44 (0) 1902 867719

Email: sales@ahough.com Website: www.ahough.com